



Combination air valve Mod. ARGO

The CSA combination, triple function, automatic air valve Mod. ARGO, for irrigation and treated water applications, will ensure the proper operation allowing the release of air pockets during working conditions and the evacuation and entrance of large volumes of air during filling and draining operations.



Technical features and benefits

- Single chamber body PN 16 bar rated, provided with internal ribs for accurate guiding of the float.
- The aerodynamic full bore body prevents premature closures of the mobile block also at high velocity air intake and discharge.
- Available with bias kits for air discharge only (EO), entrance only (IO) and anti-shock (AS) feature.
- Drainage valve for chamber control and pressure relief during maintenance available on request.
- Maintenance can be easily performed from the top, without removing the air valve from the pipe.
- Compact and reliable structure whose parts are fully corrosion, chemical resistant. Lower maintenance.
- Designed in compliance with EN 1074/4 standard.
- Approved for potable water use.
- Factory approval and quality control following ISO 9001:2008.

Applications

- Main irrigation networks.
- Water distribution networks.
- Cooling systems, process and industrial plants.
- In general this model is used on changes in slope and at the high points of the pipeline.

Operating principle - ARGO 3F

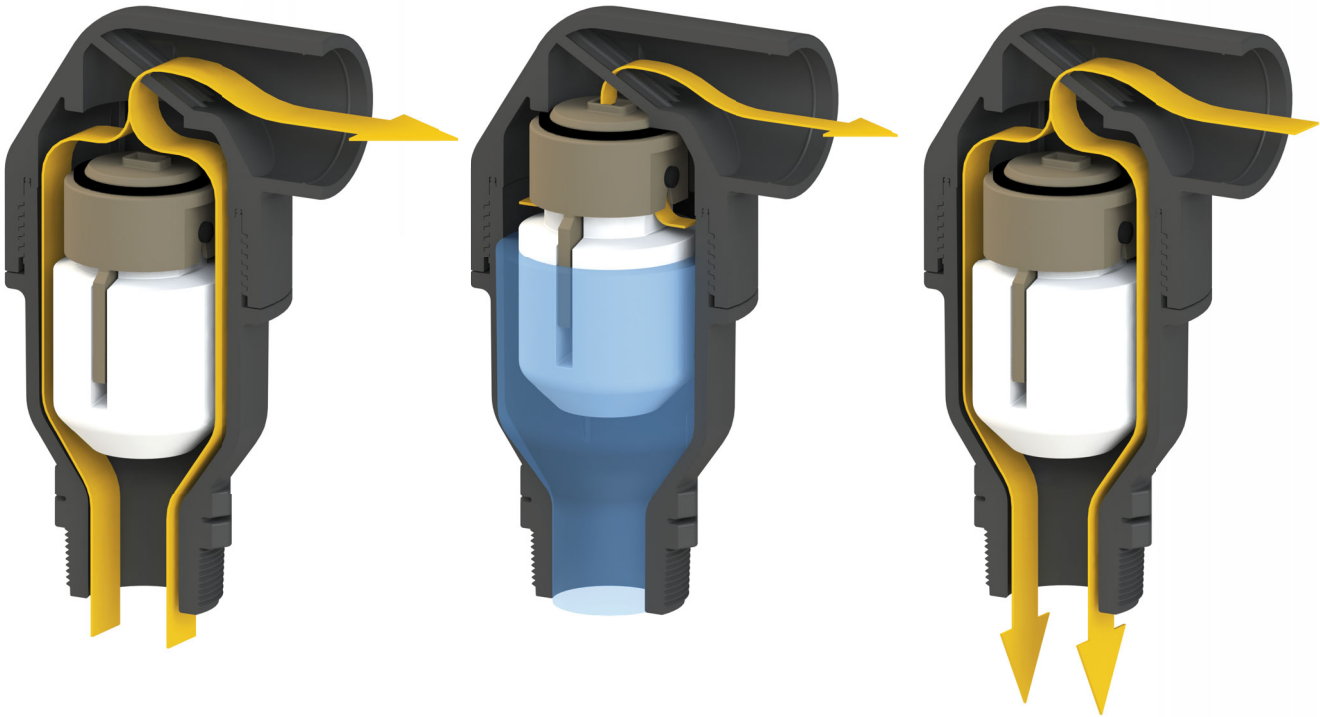

Discharge of large volumes of air

During the pipe filling it is necessary to discharge air as water flows in. The air valve ARGO 3F, thanks to the aerodynamic full port body and float, will make sure to avoid premature closures of the mobile block during this phase.

Air release during working conditions

During operation the air produced by the pipeline is accumulated in the upper part of the air valve. Little by little it is compressed and the pressure arrives to water pressure, therefore its volume increases pushing the water level downwards allowing the air release through the automatic orifice.

Entrance of large volumes of air

During pipeline draining, or pipe bursts, it is necessary to bring in as much air as the quantity of outflowing water to avoid negative pressure and serious damages to the pipeline, and to the entire system.

Technical data - ARGO 3F

Air flow performance charts

AIR DISCHARGE DURING PIPE FILLING

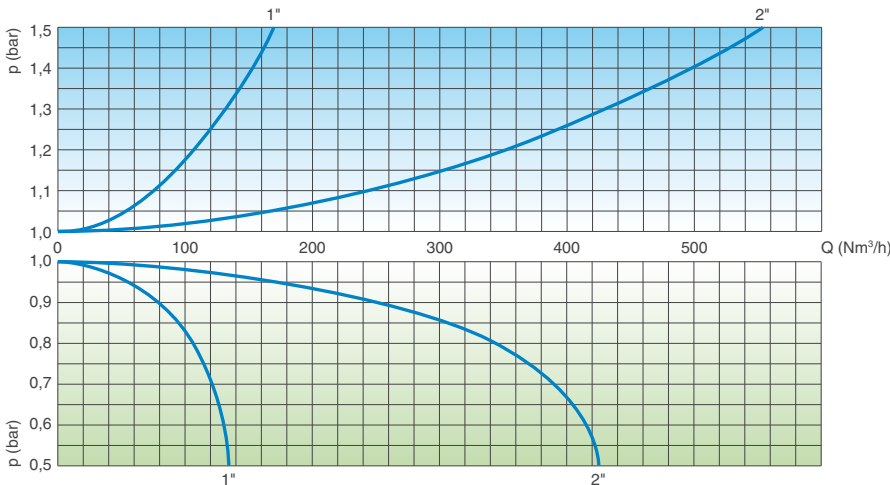

AIR ENTRANCE DURING PIPE DRAINING

AIR RELEASE DURING WORKING CONDITIONS

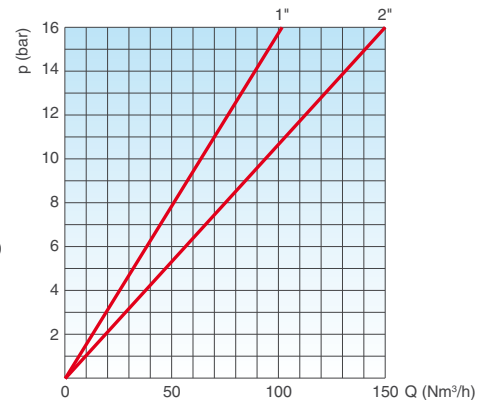

The air flow charts were created in Kg/s from laboratory tests and numerical analysis, then converted in Nm³/h using a safety factor.

Operating principle - ARGO 3F AS

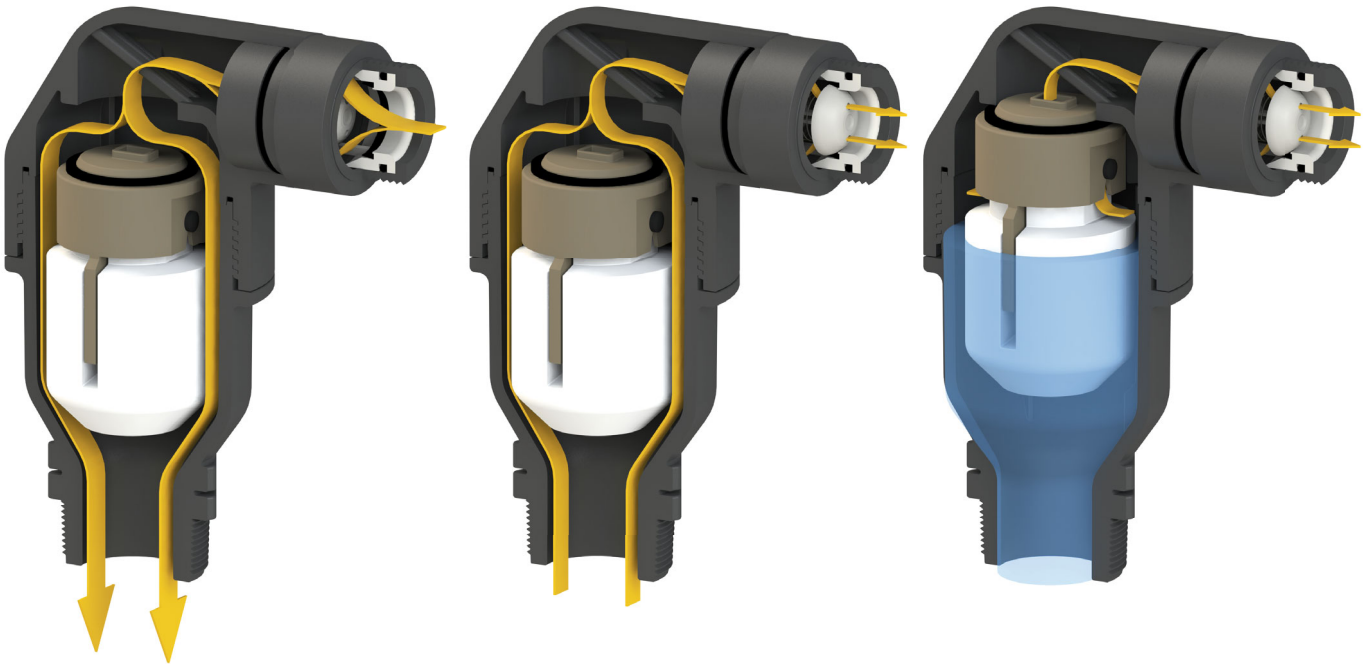

Entrance of large volumes of air

During pipeline draining, or pipe bursts, it is necessary to bring in as much air as the quantity of outflowing water to avoid negative pressure and serious damages to the pipeline, and to the entire system.

Controlled air discharge

During the air discharge it is necessary to avoid rapid closures of the float, responsible of water hammer effects. The anti-shock device will control the air outflow reducing the velocity of the approaching water column and minimizing the risk of overpressure.

Air release during working conditions

During operation the air produced by the pipeline is accumulated in the upper part of the air valve. Little by little it is compressed and the pressure arrives to water pressure, therefore its volume increases pushing the water level downwards allowing the air release through the automatic orifice.

Technical data - ARGO 3F AS

Air valve selection chart

Air valve preliminary sizing as a function of pipeline internal diameter and fluid flow velocity in m/s.

Pipe DN (mm)

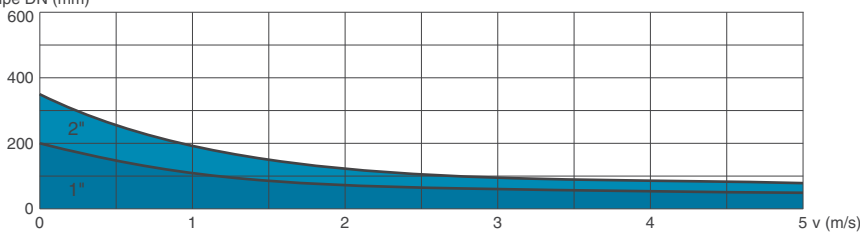

Air flow performance charts

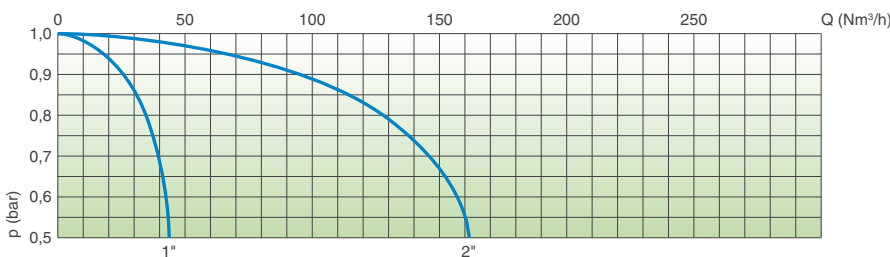

AIR ENTRANCE DURING PIPE DRAINING

AIR RELEASE DURING WORKING CONDITIONS

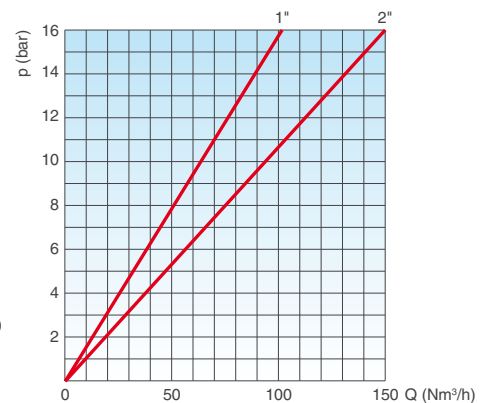

The air flow charts were created in Kg/s from laboratory tests and numerical analysis, then converted in Nm³/h using a safety factor.

Technical details

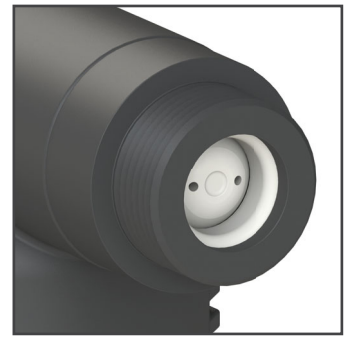
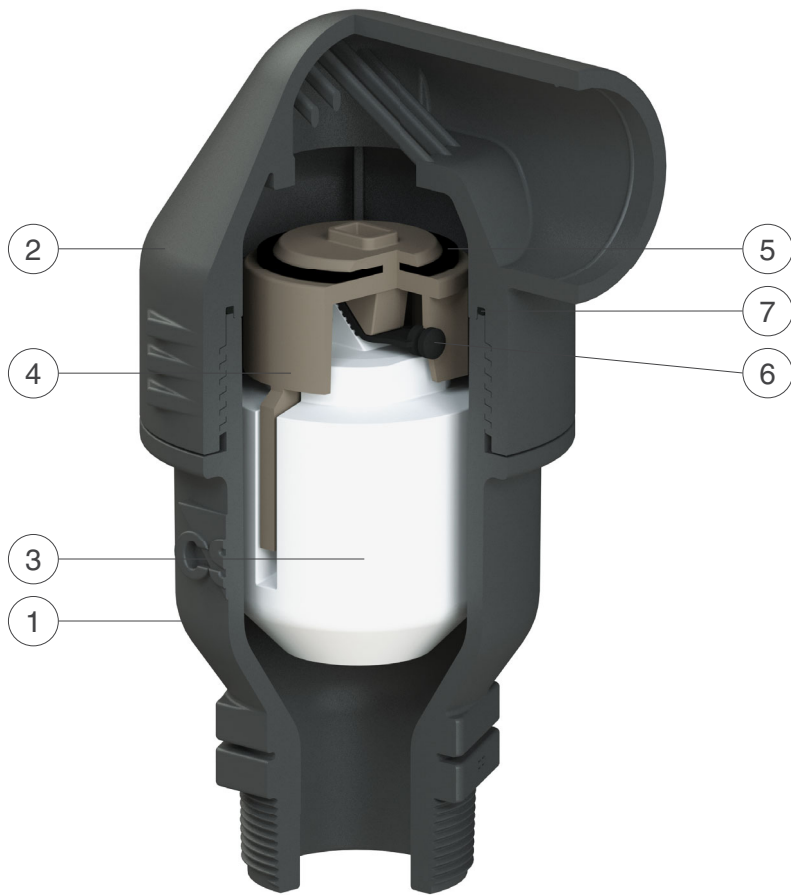

AS/IO device in polypropylene with threaded connection 2".

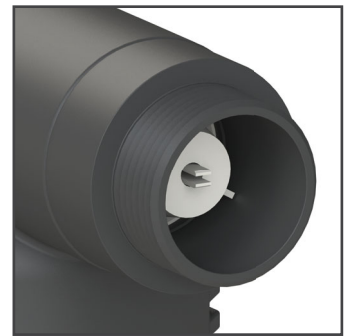

EO device in polypropylene with threaded connection 2".

N.	Component	Material	Features
1	Body	glass reinforced polypropylene	provided with ribs for accurate guiding
2	Cap	glass reinforced polypropylene	provided with protection grid
3	Float	polypropylene	solid and resistant to high pressure
4	Kinetic plug	glass reinforced polyamide	with high air release capacity
5	Kinetic orifice seal	EPDM	
6	Automatic orifice seal	EPDM	
7	O-ring	EPDM	

The list of materials and components is subject to changes without notice.

Working conditions

Treated water max. 60°C.
Max. pressure 16 bar.
Min. pressure 0,2 bar;
lower on request.

Valve selection

Body material: glass-reinforced PP.
Inlet size: DN 25, DN 50 (1", 2").
Connections: threaded male BSPT or NPT.
Certified in compliance with EN-1074/4.

Nozzle specification

air valve size	kinetic orifice		autom. or.
	d (mm)	A (mm ²)	A (mm ²)
1"	21	346	5
2"	45	1590	12

Weights and dimensions

CONNECTION (E) inch	A mm	B mm	C mm	D mm	Weight Kg
Threaded 1"	80	167	92	CH 41	0,3
Threaded 2"	110	226	135	CH 65	0,75

All values are approximate, consult CSA service for more details.

