

SIGMA

UG Diaphragm Gas Meters

- Synthetic Diaphragm, suitable for a wide range of temperatures
- Suitable for natural gas, city gas and propane-butane gas
- High Measuring Stability
- Low Noise and Low Pressure Loss
- Pre-equipped Pulsed Output
- Back Flow Protection
- MID Approved
- Supplied with unions



Technical Data

		UG-G4P	UG-G6P	UG-G10P	UG-G16P	UG-G25P
Minimum flow rate	m ³ /h	0.04	0.06	0.10	0.16	0.25
Maximum flow rate	m ³ /h	6	10	16	25	40
Max working pressure	bar	0.5	0.5	0.5	0.5	0.5
Pulse output value	m ³	0.01	0.01	0.1	0.1	0.1

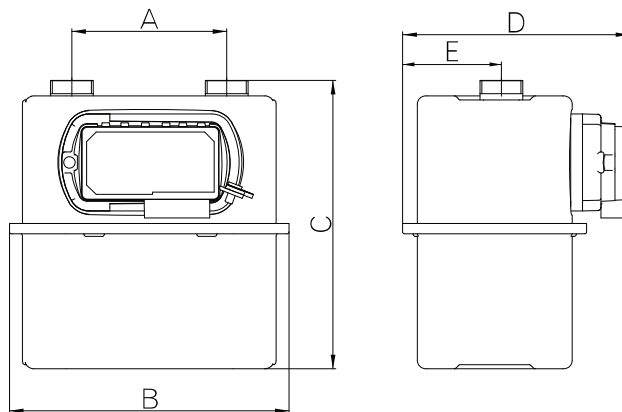

Dimensions

		UG-G4P	UG-G6P	UG-G10P	UG-G16P	UG-G25P
Union Connection		¾" ISO BSP	1" ISO BSP	1¼" ISO BSP	1½" ISO BSP	2" ISO BSP
Pipe Centers - A	mm	110	250	250	280	280
Width - B	mm	200	325	393	393	456
Height - C	mm	208	222	365	345	380
Depth (Index) - D	mm	161	177	214	214	313
Depth (Pipe) - E	mm	70	73	91	91	141
Weight	kg	1.7	3.2	7.4	6.8	12



SIGMA

Curves of Typical Error and Pressure Loss

UG-G4P

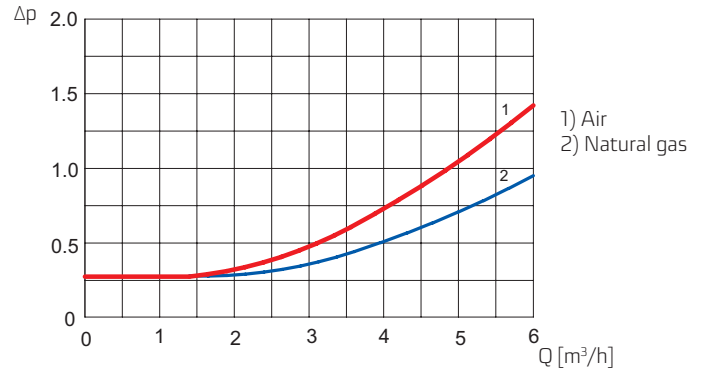
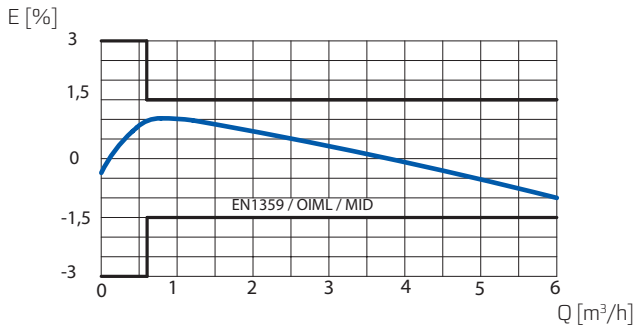

UG-G6P

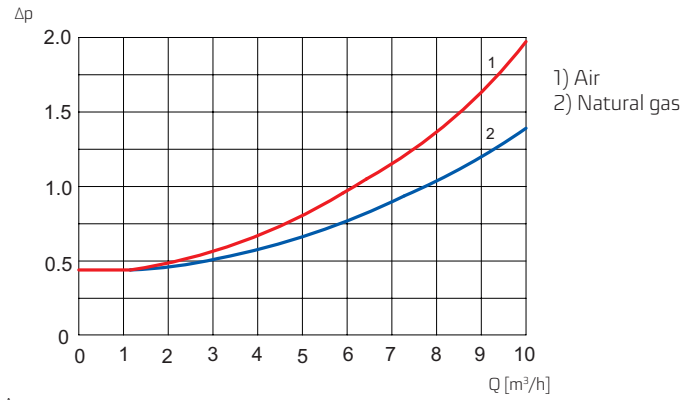
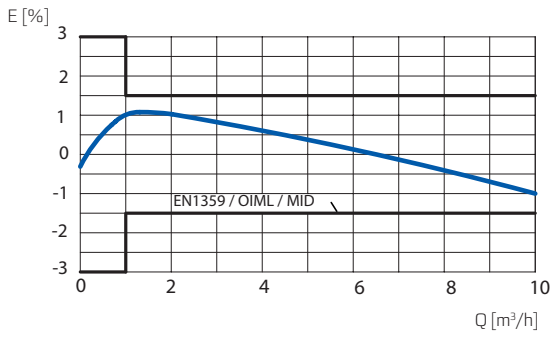

UG-G10P

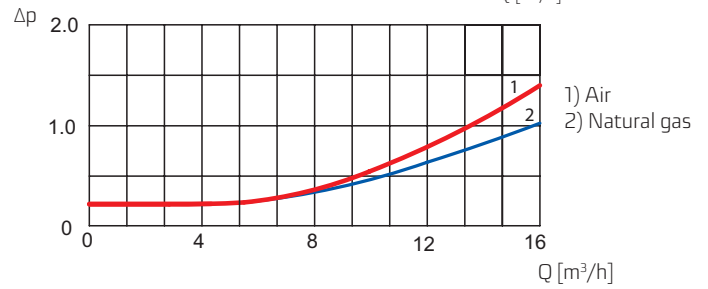
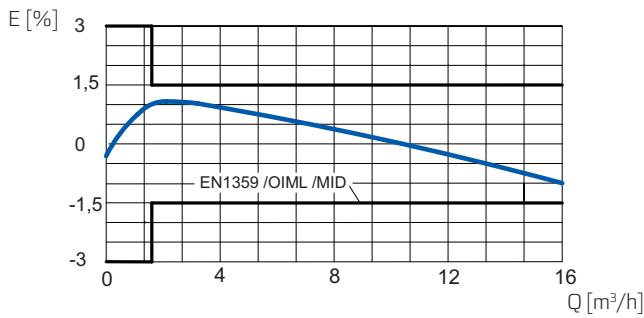

UG-G16P

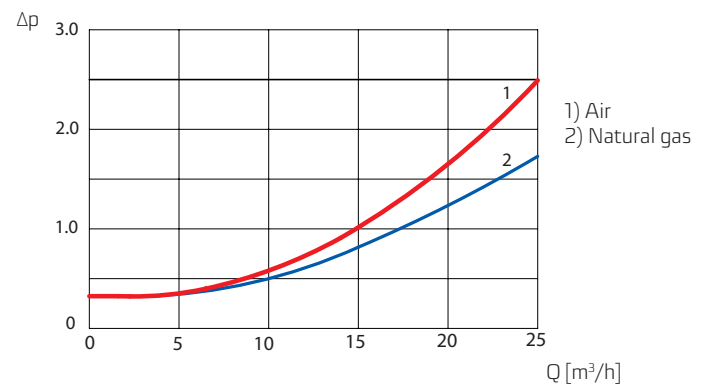
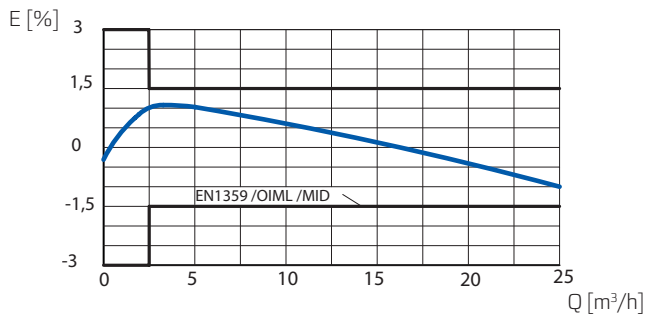

UG-G25P

